

> PSA INOX-STAR <
> PSA VRS <
for 1-2 persons



Safety instructions

This safety instruction has to be kept on file for the whole lifetime of the product and forwarded with the product.

TRANSLATION OF THE ORIGINAL INSTRUCTIONS



RUD Ketten
Rieger & Dietz GmbH u. Co. KG
73432 Aalen
Tel. +49 7361 504-1370
sling@rud.com
www.rud.com

RUD-Art.-Nr.: 7905319-EN V06 - 04.024

PSA – Fall Protection
Anchorage Point



Eye bolt made
out of stainless
Duplex-steel
PSA INOX-STAR
for 1-2 persons
M16
M20

VIP-Eye bolt
PSA VRS
for 1-2 persons
M16 / 5/8"-11 UNC
M20 / 3/4"-10 UNC

Testing regulation: DIN CEN / TS 16415:2013-04,
EN 795:2012-10,
DIN EN 50308 2004 Abs. 4.5,
OSHA 1926.502 (d)(15)

Other regulation: AS/NZS 5532:2013

Notifying department: Kennn Identification No: **0299**
FA PSA Test- and Certification department of DGUV Test
Zwengenberger Straße 68
42781 Haan

Declaration of conformity	
Manufacturer:	RUD Ketten Rieger & Dietz GmbH u. Co. KG Friedensinsel 73432 Aalen Germany
Based on the tests carried out in accordance with DGUV Guideline 300-003(January 2015 edition), we hereby declare that the subsequently described anchor point, both in its design and construction and in the form as delivered, complies with the essential health and safety requirements of EC Directive 2001/95/EC. This declaration shall no longer be valid if changes are made to the anchor point without our authorisation.	
Product name:	Anchor point PSA-INOX-STAR for securing a personal fall protection system in accordance with DIN EN 795 2012-10 or DIN EN CEN/TS 16415: 2013-04
The following harmonized norms were applied:	
DIN CEN/TS 16415 : 2013-04	DIN EN 50308 : 2004
DIN EN 795 : 2012-10	DIN EN ISO 12100 : 2011-03
EN 365 : 2004-12	
The following national norms and technical specifications were applied:	
AS/NZS 5532 : 2013	DGUV-R 112-198 : 2019-09
OSHA 1926.502	
Notifying department:	FB PSA Test- and Certification department of BG-PRÜFZERT Identification No.: 0299
Authorized person for the configuration of the declaration documents:	Michael Betzler, RUD Ketten, 73432 Aalen
Aalen, den 20.04.2018	Hermann Kolb, Bereichsleitung MA

Declaration of conformity	
Manufacturer:	RUD Ketten Rieger & Dietz GmbH u. Co. KG Friedensinsel 73432 Aalen Germany
Based on the tests carried out in accordance with DGUV Guideline 300-003(January 2015 edition), we hereby declare that the subsequently described anchor point, both in its design and construction and in the form as delivered, complies with the essential health and safety requirements of EC Directive 2001/95/EC. This declaration shall no longer be valid if changes are made to the anchor point without our authorisation.	
Product name:	Anchor point PSA-VRS for securing a personal fall protection system in accordance with DIN EN 795 2012-10 or DIN EN CEN/TS 16415: 2013-04
The following harmonized norms were applied:	
DIN CEN/TS 16415 : 2013-04	DIN EN 50308 : 2004
DIN EN 795 : 2012-10	DIN EN ISO 12100 : 2011-03
EN 365 : 2004-12	
The following national norms and technical specifications were applied:	
AS/NZS 5532 : 2013	DGUV-R 112-198 : 2019-09
OSHA 1926.502	
Notifying department:	FB PSA Test- and Certification department of BG-PRÜFZERT Identification No.: 0299
Authorized person for the configuration of the declaration documents:	Michael Betzler, RUD Ketten, 73432 Aalen
Aalen, den 20.04.2018	Hermann Kolb, Bereichsleitung MA



Before every use, please read the Safety Instruction of the PSA-Fall protection anchorage point (PSA INOX-STAR / PSA VRS for 1-2 persons) carefully and make sure that you understand all substance. Improper use or care of this eyebolt can result in bodily injury or property damage and eliminates any warranty!

1 Application and warning information



WARNING

Improper assembled or damaged PSA INOX-STAR/PSA VRS for 1-2 persons and inappropriate use can result in deadly injury or lead to heavy injuries when load drops. Inspect PSA INOX-STAR/PSA VRS for 1-2 persons before each use carefully!

- PSA INOX-STAR / PSA VRS for 1-2 persons must only be used by competent and trained people with adequate knowledge, and outside Germany, the corresponding country specific requirements must be utilised.
- **PSA VRS for 1-2 persons are not suitable for permanent outdoor use. Changing weather conditions can cause corrosion and wear of material.**
- The user of the PSA INOX-STAR / PSA VRS for 1-2 persons must be in good health to use this equipment. The hereby necessary certification can f.e. be verified by a G41-checkup.
- The PSA INOX-STAR / PSA VRS for 1-2 persons must only be loaded with the stated number of persons.
- To enable safety and appropriate information for all users in case of a resell to another country, the reseller must provide the user instruction, maintenance instruction for the regular inspection and the repairing in the country specific language.

2 Intended use

PSA INOX-STAR / PSA VRS for 1-2 persons can be used as anchor point, for fall protection harnesses. This anchor point (subsequently named PSA-Fall protection anchorage point) can also be attached permanent to a building, so that a fall protection harness can be hooked in.

PSA INOX-STAR / PSA VRS for 1-2 persons must only be used as personal fall arrest equipment (and not for lifting purposes).

Only for a rescue from height and depth additional emergency descent devices must be attached (see DGUV regulation 112-199 chapter 5.3.8.1 load accepting devices).

PSA INOX-STAR / PSA VRS for 1-2 persons are designed to stand pivoting movements under load as they can occur during a fall.

PSA INOX-STAR / PSA VRS for 1-2 persons are not designed to be used for permanent swiveling under load, because they can turn loose when turned under load. Please observe the following WLL:

PSA INOX-STAR / PSA VRS for 1-2 persons are permissible for max. 2 Persons.

PSA INOX-STAR / PSA VRS for 1-2 persons are able to take all possible occurring forces in any loading directions if used in the intended way as fall arrest protection devices.

PSA VRS for 1-2 persons are not suitable for permanent outdoor use. Changing weather conditions can cause corrosion and wear of material. For outdoor applications we recommend to use the PSA INOX-STAR for 1-2 persons (stainless steel).

In consequence of the assembly method this product fulfills the requirements as described in DIN EN 795:2012 paragraph 3.2.1:

Fall protection anchorage device type A

Fall protection anchorage device which includes when installed, either one or multiple stationary anchor point(s) and if for their fixing at the structural facility a stationary installed anchor point or a fixing element is necessary.

PSA INOX-STAR / PSA VRS for 1-2 persons must only be used for the in the user instruction specified purposes.

3 Installation information

3.1 General information

- Capability of temperature usage:
PSA INOX-STAR / PSA VRS for 1-2 persons can be used in the temperature range between -40°C up to 280°C.
- PSA INOX-STAR / PSA VRS for 1-2 persons must not be used under chemical influences such as acids, alkaline solutions and vapours. Please observe 2 *Intended use*.
- Pay attention during transport and storage of the PSA INOX-STAR / PSA VRS for 1-2 persons that the thread will not be damaged.



HINT

The bolt is hold captive in the housing by 4 compressions (indentations).

- A plan must exist to accomplish rescue actions, including all kinds of possible emergencies occurring with the work.
- If the PSA INOX-STAR / PSA VRS for 1-2 persons is used in mobile applications, it must be handed out to the user personally.
- Modifications or repairing on the PSA INOX-STAR / PSA VRS for 1-2 persons must be carried out by the manufacturer only.

- Store PSA INOX-STAR / PSA VRS for 1-2 persons at dry and non corrosive environment only.
- Correct maintenance and storage of PSA INOX-STAR / PSA VRS for 1-2 persons are important for the safety of the worker.

3.2 Assembly information

1. The material construction to which the PSA INOX-STAR / PSA VRS for 1-2 persons will be attached should be of adequate strength to withstand forces without deformation (certificate of static forces).

We recommend engaging assessors from the respective national standards/regulations during the design of the installation area. Example:

	1 person	2 persons
DIN EN 795	12 kN	see DIN CEN/TS 16415
DIN CEN/TS 16415	see DIN EN 795	13 kN
OSHA 1926.502(d)(15)	22.2 kN	44.4 kN

Table 1: Test forces

Bolt-in lengths derived from the Employer's Liability Insurance Association:

- 1.5 x M in steel (min. grade S235JR [1.0037])
- 1.5 x M in grey cast iron (f.e. GG 25)

Furthermore, the Employer's Liability Insurance Association recommends as minimum bolt-in lengths:

- 2 x M in aluminium alloys
- 2.5 x M for light metals of low strength (M = size of thread, f.e. M16, means 16 mm thread diameter)

When used in light metals, nonferrous metals and grey cast iron or other materials the thread has to be chosen in such a way that the WLL of the thread corresponds to the requirements of the corresponding base material.



HINT

PSA INOX-STAR / PSA VRS for 1-2 persons are standard wise supplied with a thread lengths of 1.5 x M. Make sure that the tapped hole is providing enough depth (see also chapter 3.2 Assembly information – point 5).

If the PSA INOX-STAR / PSA VRS for 1-2 persons will be attached to a through hole, the bore must be carried out according to DIN EN 20273 range „m“. When using a nut please choose a commercially available lock-nut acc. to DIN EN ISO 7042 with washer or use an equivalent bolt securing device to avoid unintentional loosening of screw joint. Should a disassembly of the lock-nut become necessary, it is mandatory to use a new lock-nut and the thread of the bolt must be inspected.

2. The bolting location for the PSA INOX-STAR / PSA VRS for 1-2 persons should be marked with paint.

3. PSA INOX-STAR / PSA VRS for 1-2 persons should be installed as follows:
 - Position above the user (this does not exclude other installation positions) reduces.
 - risk of tripping, the height of fall and swinging after a tumble.
 - the coupling element must be free moveable, the coupling element must not be loaded over edges.
4. Make sure that a plane bolting surface is provided ($\varnothing E$, see Table 3). Maximum countersink of the threaded hole = Nominal diameter of thread.
5. Drill the tapped blind holes deep enough so that the shoulder of the PSA INOX-STAR / PSA VRS for 1-2 persons bolt sits properly on the plane surface. At through holes please consider also DIN EN 20273 middle.
6. PSA INOX-STAR / PSA VRS for 1-2 persons must be able to turn by 360° around the bolt axle when it's completely installed.

Temporarily installed PSA INOX-STAR / PSA VRS for 1-2 persons:

For a temporarily installation/loading at the load force transmission point, hand tightening of the bolt with an allen key or a suitable tool, applied with normal hand force (approx. 50 daN) into the designed and determined thread is sufficient.

Permanent installed PSA INOX-STAR / PSA VRS for 1-2 persons:

For an applicable permanent installation/loading at the force transmission point, the PSA INOX-STAR / PSA VRS for 1-2 persons must be bolt in by using a suitable setscrew and a torque wrench into the designed thread. The necessary clamping and fastening torque value ($\pm 10\%$) can be taken out of Table 2.

It is possible to receive a socket wrench for the usage of a torque:

Type	tightening torque [Nm]	Ref.-No. of key
PSA M16	60	7997751
PSA M20	115	7997752

Table 2:

As an additional securing the usage of liquid bolt securing f.e. Loctite or WEICONLOCK (observe manufacturer's instruction) should be used. Assembly of the PSA INOX-STAR / PSA VRS for 1-2 persons must only be carried out in such a way that a disassembly can only be done with suitable tools.

3.3 User information

- Inspect PSA INOX-STAR / PSA VRS for 1-2 persons regularly before each usage in regard of tightening, corrosion, wear, deformation etc. (see chapter 4 *Inspection / Repair / Disposal*).



WARNING

Wrong assembled or damaged PSA INOX-STAR / PSA VRS for 1-2 persons as well as incorrect usage may result in serious or deadly injuries.

PSA INOX-STAR / PSA VRS for 1-2 persons must be in general inspected before each usage.

- If a safe usage is doubtful or if the PSA INOX-STAR / PSA VRS for 1-2 persons has been stressed by a dropped load, for safety reasons the usage must be withdrawn.
A competent person must decide whether the lifting mean can be used further on.
- PSA INOX-STAR / PSA VRS for 1-2 persons has to be adjustable through 360° when fitted and completely installed.



HINT

*Attention: PSA INOX-STAR / PSA VRS for 1-2 persons are **not suited for permanent turning under load!***

- When composing harness equipment to a disposal system make sure that they are supposed to be put together and that the coupling element is compatible with the PSA INOX-STAR / PSA VRS for 1-2 persons.
- If the PSA INOX-STAR / PSA VRS for 1-2 persons is used as part of a fall protection system, make sure that the following requirements are guaranteed: Devices must be used which are limiting the max. dynamical forces, which can occur to the user during a fall, to max. 6 kN.
- Care should be taken when selecting components of equipment to avoid any risk of injury to persons or damage of property. The safe function of a component or a compromised equipment must not be effected.
- Eliminate any damage of the PSA INOX-STAR / PSA VRS for 1-2 persons for example caused by loading on sharp edges.
- The assembly of a PSA INOX-STAR / PSA VRS for 1-2 persons to a coupling element must be done by using coupling elements according to EN 362 (Grade B and M), which have to free moveable to all sides. Any other grades are prohibited. Exception: Grade T is allowed, depending on the shape. Squeezing, tripping, shear and joint locations must be avoided. The coupling element must not be kinking when loaded.

- Karabiner hooks according to DIN 5290 are prohibited.
- PSA INOX-STAR / PSA VRS for 1-2 persons can be combined with hook clamps according to DIN EN 362 A under the following conditions:
 - Use by only one person
 - No transverse load of hook clamp
 - Hook clamp must be freely movable.
- For a body harness (belt type) in a fall protection system only harness belts according to EN 361 must be used.
- Make sure when using fall arrest anchor systems that it is decisive for the safety of the user to guarantee that enough space below the working area is existing. In case of a fall there will be no impact at the ground or an obstacle be possible.
- Hook coupling element of the selected harness system into the eye of the PSA INOX-STAR / PSA VRS for 1-2 persons and lock the coupling accordingly.
- Improper use of the PSA INOX-STAR / PSA VRS for 1-2 persons cause limitations in regard of the usage period. The system must be inspected and controlled according to chapter 4 *Inspection / Repair / Disposal*.
- In addition to that please observe user instruction of all other components also.

4 Inspection / Repair / Disposal

4.1 Hints for the regularly inspection

The operator has to determine and dictate the necessary inspection periods and the deadlines by a risk assessment (see sections 4.2 and 4.3).

The persisting appropriateness of the PSA INOX-STAR / PSA VRS for 1-2 persons must be checked by a competent person (auditor) at least once per year.

Depending on the conditions of use e.g. frequent use, increased wear or corrosion, it may be necessary to carry out inspections at shorter intervals than once per year. A verification is also required following damage and after special events. The operator must specify the test cycles.

Please fill out the documentation card carefully and save it to write down regular inspections and possible repairs.

If necessary you can leave a mark at the component informing about the latest and up-coming inspection.

4.2 Inspection criteria for the regularly examination carried out by the operator

- The product identification at the PSA INOX-STAR / PSA VRS for 1-2 persons must be high visible and easy to read.
- Observe proper tightening of bolt.
- The plane area of the PSA INOX-STAR / PSA VRS for 1-2 persons can completely flat down to the work piece.
- Completeness of the PSA INOX-STAR / PSA VRS for 1-2 persons.
- Complete, readability of the Working Load Limit (WLL) as well as existing sign of manufacturer and bolt.
- Correct screw size and screw-in length.
- Deformation on load bearing parts like basic body and bolt.
- Easy turning of the ring, free of jerk must be assured.
- Mechanical damages like notches, especially when located in areas of tensile stress.

4.3 Additional inspection criteria for the competent person resp. auditor

- strong corrosion
- Inspection of cross section reduction is only necessary if noticable abnormalities can be seen. In this juncture the 10 % wear reduction regulation becomes valid.
- Function and damage of bolts and threads, if it's visible.
- Additional inspections may be necessary depending on the result of the risk assessment (e.g. incipient cracks at load bearing parts).

4.4 Hint for the maintenance

For cleaning the PSA INOX-STAR / PSA VRS for 1-2 persons use only solvent- and acid-free cleaning supplies.

4.5 Disposal

Dispose worn out components / attachments or packaging according to the local waste removal requirements.

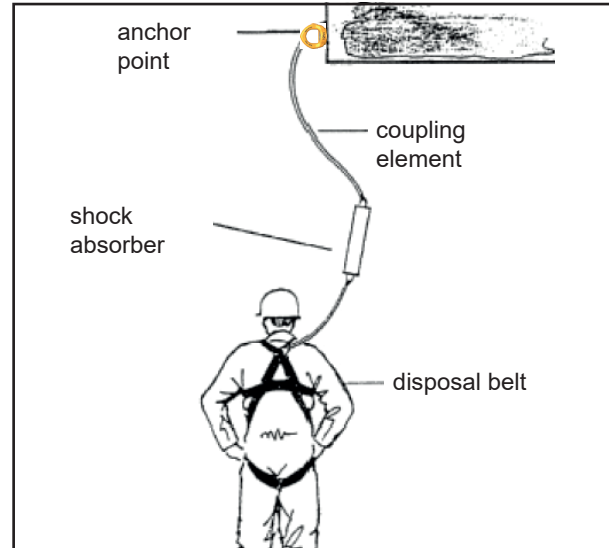

Pic. 1: Overview disposal system with shock absorber (source: BGR/GUV-R 198, 03/2011, page 13 picture 7)

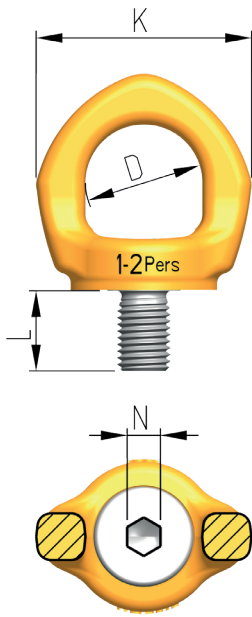

Pic. 2: Drawing PSA INOX-STAR for 1-2 persons

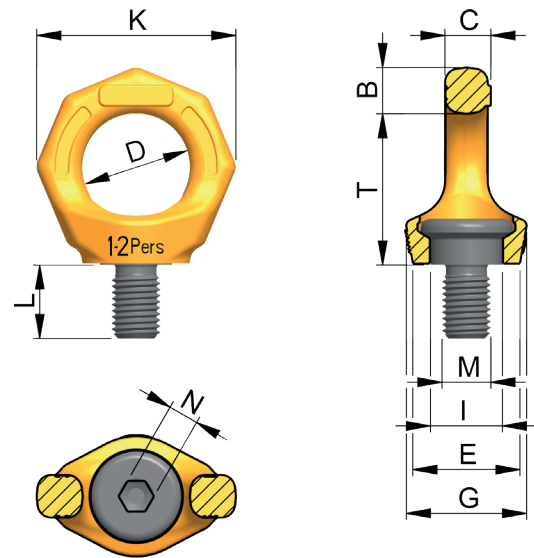

Pic. 3: Drawing PSA VRS for 1-2 persons

PSA INOX-STAR - [1-2 persons]															
Type PSA INOX-STAR	WLL. [pers.]	weight [kg / pc.]	T [mm]	B [mm]	C [mm]	D [mm]	E [mm]	G [mm]	I [mm]	K [mm]	L [mm]	M	N [mm]	pack- aging unit [pc.]	Ref.-No.
M16	1-2	0.37	50	15	14	35	44	45	22	65	24	M16	10	1,000	7912513
														10	7912518
M16	1-2	0.39	50	15	14	35	44	45	22	65	50	M16	10	10	7912514
M16	1-2	0.56	50	15	14	35	44	45	22	65	120	M16	10	10	7912515
M20	1-2	0.53	58	19	17	40	43	47	27.5	74	30	M20	12	10	7900921
M20	1-2	0.6	58	19	17	40	43	47	27.5	74	60	M20	12	10	7901252
PSA VRS - [1-2 persons]															
Type PSA VRS	WLL. [pers.]	weight [kg / pc.]	T [mm]	B [mm]	C [mm]	D [mm]	E [mm]	G [mm]	I [mm]	K [mm]	L [mm]	M	N [mm]	pack- aging unit [pc.]	Ref.-No.
M16	1-2	0.31	49	15	15	35	35	39	23.5	65	24	M16	10	10	7997854
M16	1-2	*	49	15	15	35	35	39	23.5	65	25- 120	M16	10	--	8600401
5/8" - 11 UNC	1-2	0.31	49	15	15	35	35	39	23.5	65	24	5/8" - 11 UNC	3/8"	10	7998659
M20	1-2	0.53	58	18	17	40	42	54	29.3	75	30	M20	12	10	7900920
3/4" - 10 UNC	1-2	0.5 kg	58	18	17	40	42	54	29.3	75	29	3/4" - 10 UNC	1/2"	10	7903367

Table 3: Technical data

* weight depends on the design

Subject to technical alterations

5 Marking of the PSA INOX-STAR / PSA VRS for 1-2 persons

The markings are according to DIN EN 365 „Personal fall protection gear“ – general requirements for user instructions and marking.

* Recommendation for marking the next or last inspection (topside).

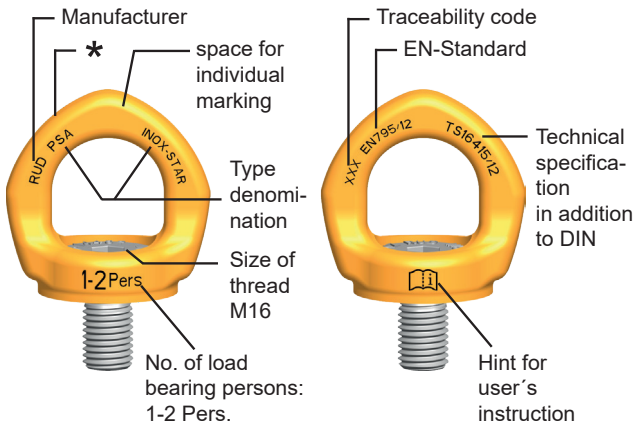

PSA INOX-STAR for 1-2 persons (M16)

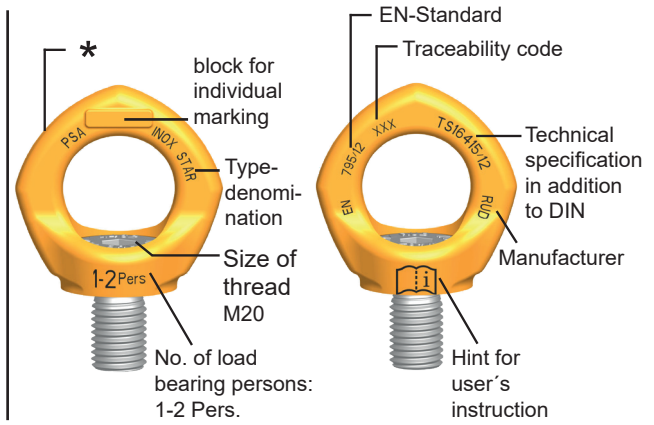

PSA INOX-STAR for 1-2 persons (M20)

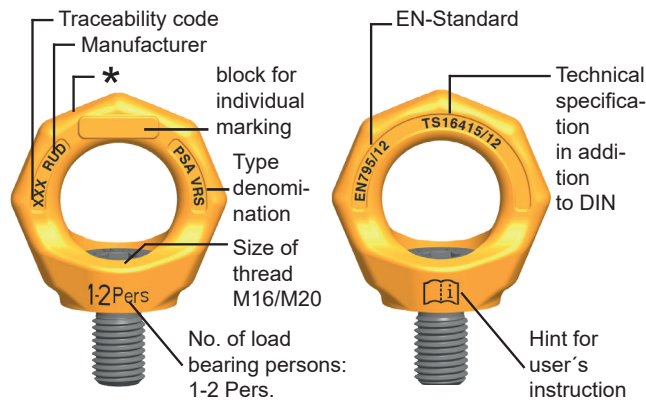

PSA VRS for 1-2 persons (M16 / M20)

6 Inspection card

Product						
Type		Trade name		Year of production		
Individual No. (if available)				Date of purchase		
Forge code						
Manufacturer: RUD Ketten Rieger & Dietz GmbH u. Co. KG Friedensinsel, 73432 Aalen, Germany Contact sling@rud.com / Tel. +49 7361 504-1370						
Sequence of regular inspections						
Date	Inspection	Repairing	OK	Detected fault	Name and signature of technical expert	Date of next regular inspection
 <p>Before PSA INOX-STAR / PSA VRS for 1-2 persons will be used, please read user instruction carefully. Make sure that you understand all the substance. Non-observance of this instruction may cause serious personal injury and/or damage to property!</p>						